



Yealink IP Phone

SIP-T29G

Contents

- Packaging Contents3
- Assembling the Phone.....3
- Startup.....6
- Configuring Your Phone.....6
 - Configuring via web user interface6
 - Configuring via phone user interface.....7
- Basic Call Features7
 - Placing a Call7
 - Answering a Call.....8
 - Ending a Call.....8
 - Redial8
 - Call Mute and Un-mute.....8
 - Call Hold and Resume8
 - Call Transfer8
 - Call Forward.....9
 - Call Conference.....9
 - Speed Dial9
 - Voice Message 10
- Customizing Your Phone.....10
 - Call History..... 10
 - Contact Directory..... 10
 - Volume Adjustment..... 10
 - Ring Tones..... 11

PACKAGING CONTENTS

The following items are included in your package. If you find anything missing, contact your system administrator:

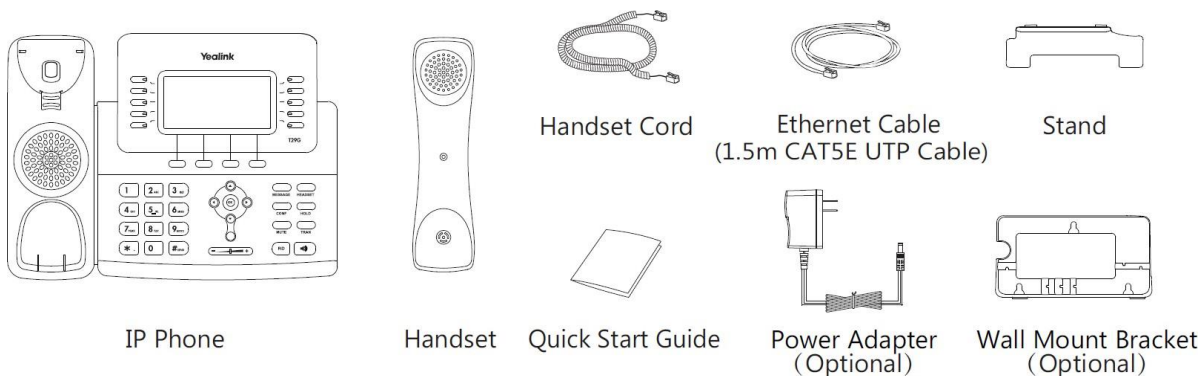

Note:

- We recommend that you use the accessories provided or approved by Yealink. The use of unapproved third-party accessories may result in reduced performance.

ASSEMBLING THE PHONE

1. Attach the stand, as shown below:

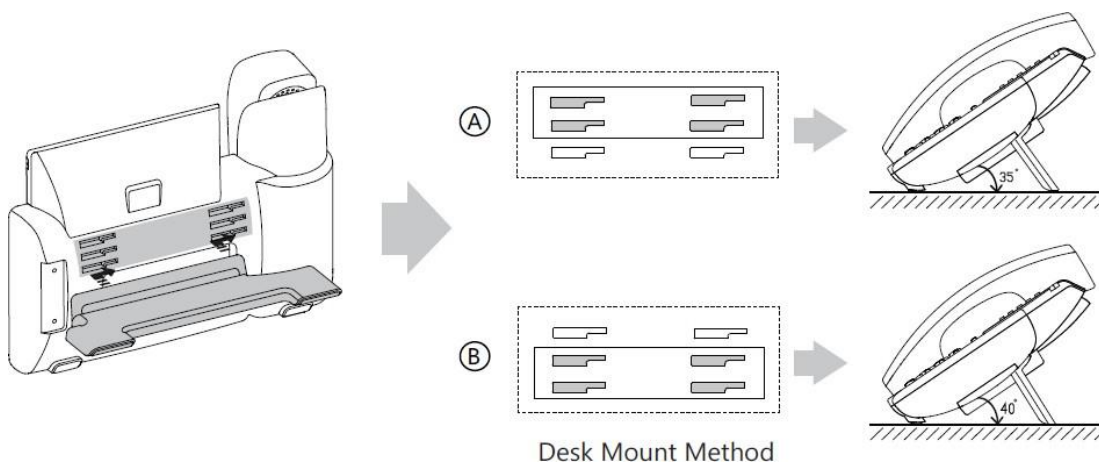

Note:

- You can also mount the phone to a wall. For more information on how to attach the wall mount bracket, refer to Yealink Wall Mount Quick Installation Guide for Yealink IP Phones.

2. Connect the handset and optional headset, as shown below:

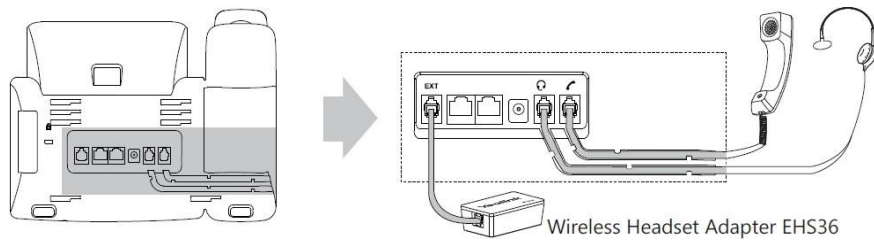

Note:

- The headset or wireless headset adapter EHS36 should be purchased separately.
- The EXT port can also be used to connect the expansion module EXP20. For more information on how to use the EHS36 and EXP20, refer to Yealink EHS36 User Guide and Yealink EXP20 User Guide.

3. Connect the USB flash drive, as shown below:

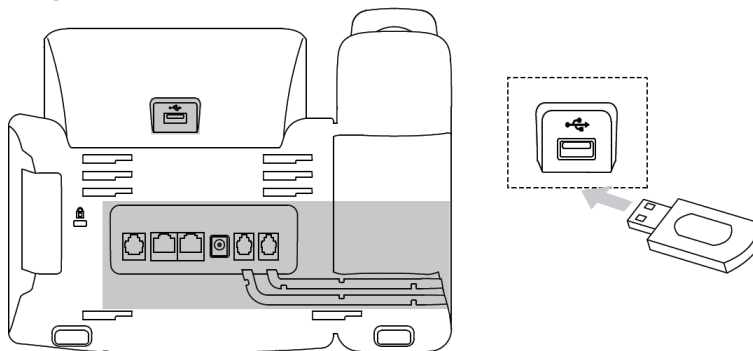

Note:

- The USB port can also be used to connect the Bluetooth USB dongle BT40 or Wi-Fi USB dongle WF40. The Bluetooth USB dongle BT40 and Wi-Fi USB dongle WF40 should be purchased separately. For more information on how to use the BT40 and WF40, refer to Yealink Bluetooth USB Dongle BT40 User Guide and Yealink Wi-Fi USB Dongle WF40 User Guide.

4. Connect the network and power, as shown below:

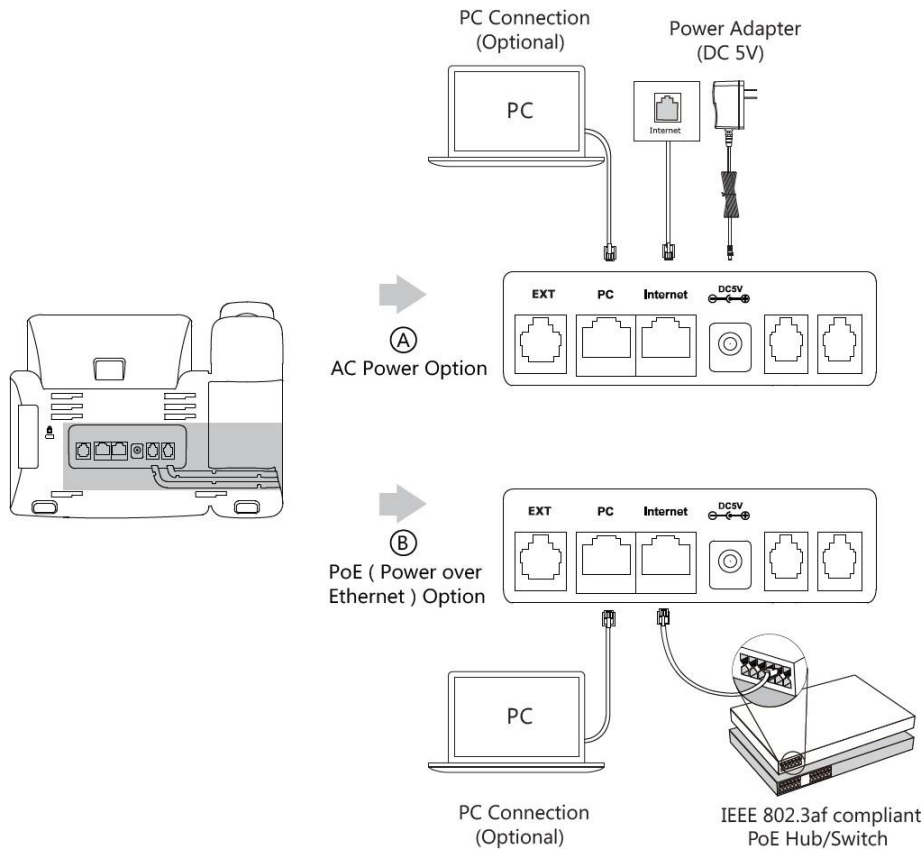

Note:

- The IP phone should be used with Yealink original power adapter (5V/1.2A) only. The use of the third-party power adapter may cause the damage to the phone. If you are connecting a PC to your phone, we recommend that you use the Ethernet cable provided by Yealink.
- If inline power (PoE) is provided, you don't need to connect the power adapter. Make sure the hub/switch is PoE-compliant.

STARTUP

After the IP phone is connected to the network and supplied with power, it automatically begins the initialization process. After startup, the phone is ready for use. You can configure the phone via web user interface or phone user interface.

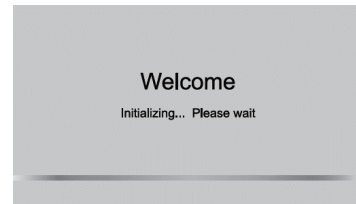

CONFIGURING YOUR PHONE

CONFIGURING VIA WEB USER INTERFACE

Accessing the web user interface:

1. Press the **OK** key when the phone is idle to obtain the IP address of the phone.
2. Open a web browser on your computer, enter the IP address into the address bar (e.g., "http://192.168.0.10" or "192.168.0.10"), and then press the **Enter**.
3. Enter the user name (default: admin) and password (default: admin) in the login page and click **Confirm**.

Network Settings: Click on **Network->Basic->IPv4 Config**

You can configure the network settings in the following ways:

DHCP: By default, the phone attempts to contact a DHCP server in your network to obtain its valid network settings, e.g., IP address, subnet mask, gateway address and DNS address.

Static IP Address: If the phone cannot contact a DHCP server for any reason, you need to configure the IP address, subnet mask, gateway address, primary DNS address and secondary DNS address for the phone manually.

Note:

- The IP phone also supports IPv6, but IPv6 is disabled by default.
- The wrong network settings may result in inaccessibility of the phone and may have an impact on the network performance. Contact your system administrator for more information.

Account Settings: Click on **Account->Register->Account X (X=1,2,3...15,16)**

Parameters of the account:

Register Status:	It shows the register status of the current account.
Line Active:	You can select Enabled/Disabled to enable/disable the account.
Label:	It is shown on the LCD screen to identify the account.
Display Name:	It is shown as Caller ID when placing a call.
User Name:	It is provided by ITSP for registration (required).
Register Name:	It is an authenticated ID for authentication provided by ITSP (required).
Password:	It is provided by ITSP for registration (required).
Server Host:	It is provided by ITSP for registration (required).

Register status icons on the LCD screen:



(Green) Registered



(Yellow) Registering



(Gray) Register Failed

Note:

- Check with your system administrator if any error appears during the registration process or a specific configuration is required for your registration.

CONFIGURING VIA PHONE USER INTERFACE

Network Settings:

Press the **Menu** soft key when the phone is idle, select **Settings->Advanced Settings** (default password: admin)->**Network->WAN Port/VLAN/Web Server/802.1x/VPN/LLDP/CDP/NAT** to configure the network.

Account Settings:

Press the **Menu** soft key when the phone is idle, select **Advanced** (default password: admin)->**Accounts** to configure the account.

Note:

- For more information on account parameters, refer to **Configuring via web user interface** above.

BASIC CALL FEATURES

PLACING A CALL

Using the handset:

1. Pick up the handset.
2. Enter the number, and then press the **Send** soft key.

Using the speakerphone:

1. With the handset on-hook, press .
2. Enter the number, and then press the **Send** soft key.

Using the headset:

1. With the headset connected, press  to activate the headset mode.
2. Enter the number, and then press the **Send** soft key.

Note:

- During a call, you can alternate between the headset, hands-free speakerphone and handset modes by pressing the **HEADSET** key, the **Speakerphone** key or by picking up the handset. Headset mode requires a connected headset.

ANSWERING A CALL

Using the handset:

Pick up the handset.

Using the speakerphone:

Press .

Using the headset:

Press  HEADSET.

Note:

- You can reject an incoming call by pressing the **Reject** soft key.

ENDING A CALL

Using the handset:

Hang up the handset or press the **EndCall** soft key.





Using the speakerphone:

Press  or the **EndCall** soft key.



Using the headset:

Press the **EndCall** soft key.

REDIAL

- Press  to enter the **Placed Calls** list, press  or  to select the desired entry, and then press  or the **Send** soft key.
- Press  twice when the phone is idle to dial out the last dialed number.

CALL MUTE AND UN-MUTE





- Press  to mute the microphone during a call.
- Press  again to un-mute the call.

CALL HOLD AND RESUME

To place a call on hold:

Press  or the **Hold** soft key during an active call.



To resume the call, do one of the following:

- If there is only one call on hold, press  or the **Resume** soft key.
- If there is more than one call on hold, press  or  to select the desired call, and then press  or the **Resume** soft key.



CALL TRANSFER

You can transfer a call in the following ways:



Blind Transfer

- Press  or the **Transfer** soft key during an active call. The call is placed on hold.
- Enter the number you want to transfer to.
- Press  or the **Transfer** soft key.

Semi-Attended Transfer

1. Press  or the **Transfer** soft key during an active call. The call is placed on hold.
2. Enter the number you want to transfer to, and then press .
3. Press  or the **Transfer** soft key when you hear the ring-back tone.

Attended Transfer

1. Press  or the **Transfer** soft key during an active call. The call is placed on hold.
2. Enter the number you want to transfer to, and then press .
3. Press  or the **Transfer** soft key when the second party answers.

CALL FORWARD



To enable call forward:

1. Press the **Menu** soft key when the phone is idle, and then select **Features->Call Forward**.
2. Select the desired forward type:



Always Forward --- Incoming calls are forwarded unconditionally.

Busy Forward --- Incoming calls are forwarded when the phone is busy.

No Answer Forward ---- Incoming calls are forwarded if not answered after a period of time.

3. Enter the number you want to forward to. For **No Answer Forward**, press  or  to select the desired ring time to wait before forwarding from the **After Ring Time** field.
4. Press the **Save** soft key to accept the change.

CALL CONFERENCE

1. Press  or the **Conference** soft key during an active call. The call is placed on hold.
2. Enter the number of the second party, and then press the **Send** soft key.
3. Press  the **Conference** soft key when the second party answers. All parties are now joined in the conference.
4. Press the **End Call** soft key to disconnect all parties.

Note:

- You can split the conference call into two individual calls by pressing the **Split** soft key.

SPEED DIAL

To configure a speed dial key:

1. Press the **Menu** soft key when the phone is idle, and then select **Features->DSS Keys**.
2. Select the desired DSS key, and then press the **Enter** soft key.
3. Select **Speed Dial** from the **Type** field, select the desired line from the **Account ID** field, enter a label in the **Label** field and then enter the number in the **Value** field.
4. Press the **Save** soft key to accept the change.

To use the speed dial key:

Press the speed dial key to dial out the preset number.

VOICE MESSAGE



Message waiting indicator on the idle screen indicates that one or more voice messages are waiting at the message center. The power indicator LED slowly flashes red and the **MESSAGE** key LED lights up.

To listen to voice messages:

1. Press  or the **Connect** soft key.
2. Follow the voice prompts to listen to your voice messages.

CUSTOMIZING YOUR PHONE

CALL HISTORY

1. Press the **History** soft key when the phone is idle, press  or  to scroll through the list.
2. Select an entry from the list, you can do the following:
 - Press the **Send** soft key to place a call.
 - Press the **Delete** soft key to delete the entry from the list.

If you press the **Option** soft key, you can also do the following:



- Select **Detail** to view detailed information about the entry.
- Select **Add to Contact** to add the entry to the local directory.
- Select **Add to Blacklist** to add the entry to the blacklist.
- Select **Delete All** to delete all entries from the list.

CONTACT DIRECTORY



To add a contact:

1. Press the **Directory** soft key when the phone is idle, and then select **All Contacts**.
2. Press the **Add** soft key to add a contact.
3. Enter a unique contact name in the **Name** field and contact numbers in the corresponding fields.
4. Press the **Add** soft key to accept the change.

To edit a contact:

1. Press the **Directory** soft key when the phone is idle, and then select **All Contacts**.
2. Press  or  to select the desired contact, press the **Option** soft key and then select **Detail** from the prompt list.
3. Edit the contact information.
4. Press the **Save** soft key to accept the change.



To delete a contact:

1. Press the **Directory** soft key when the phone is idle, and then select **All Contacts**.
2. Press  or  to select the desired contact, press the **Option** soft key and then select **Delete** from the prompt list.
3. Press the **OK** soft key when the LCD screen prompts "Delete selected item?".





Note:

- You can add contacts from call history easily. For more information, refer to **Call History** above.

VOLUME ADJUSTMENT

- Press  during a call to adjust the receiver volume of the handset/speakerphone/headset.
- Press  when the phone is idle or ringing to adjust the ringer volume.
- Press  to adjust the media volume in the corresponding screen.

RING TONES

1. Press the **Menu** soft key when the phone is idle, and then select **Basic->Sound->Ring Tones**.
2. Press  or  to select **Common** or the desired account and then press the **Enter** soft key.
3. Press  or  to select the desired ring tone.
4. Press the **Save** soft key to accept the change.

About us

Founded in 2001, Yealink, a leading provider of VoIP Phone and IP communication solutions, has been focusing on VoIP products characterized by reliable quality, easy deployment and affordable price for more than a decade. Today, customers from over 140 countries rely on Yealink as the backbone of global collaboration to extend the value of network communications.

More about Yealink

Since 2001, Yealink has continued to develop state-of-the art, hi-tech VoIP communication terminals that include IP video phones, IP phones and USB phones. With a worldwide market in more than 140 countries, the company has also established a first-class international service network.

Our priorities are quality, functionality, ease-of-use, customer support and competitive pricing. To provide new solutions for the future in this fast-evolving sector, Yealink's large, talented and highly-experienced VoIP R&D team is totally committed to the pursuit of excellence.

To date, we have passed more than 80 interoperability tests and meet certification requirements set by leading VoIP system and platforms. Yealink works in close partnership with T-Mobile, Telefonica, Portugal Telecom and other leading telecommunication service providers.



YEALINK(XIAMEN) NETWORK TECHNOLOGY CO.,LTD.
Web: www.yealink.com
Addr: 309, 3th Floor, No.16, Yun Ding North Road, Huli
District, Xiamen City, Fujian, P.R. China
Copyright©2016Yealink Inc.All right reserved.